



プレートコンパクター

MVC-F60H

(65kg)  
 本体価格:  
 ¥245,000(税抜)

MVC-F60H

(66kg)  
 中折れハンドル型  
 本体価格: ¥253,000(税抜)

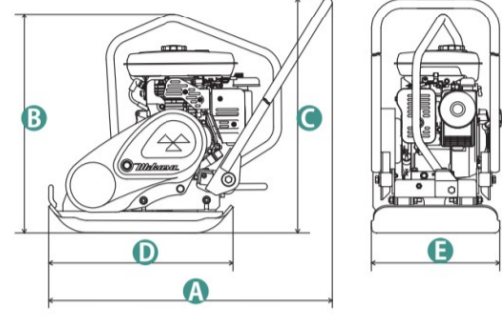

MVC-F30H

(38kg) 
 本体価格: 
 ¥231,000(税抜)

MVC-F30H

(38kg) 
 中折れハンドル型 
 本体価格: ¥239,000(税抜)

MVC-40H

(49kg) 
 本体価格: 
 ¥231,000(税抜)

MVC-50H

(58kg) 
 本体価格: 
 ¥241,000(税抜)



MVC-50HT

(61kg)  
 散水装置標準装備
 (水タンク容量8.5ℓ)
 本体価格: ¥265,000(税抜)



MVC-50HT

(62kg)  
 散水装置標準装備
 中折れハンドル型  
 本体価格: ¥273,000(税抜)

MVC-50H

(59kg) 
 中折れハンドル型 
 本体価格: ¥249,000(税抜)

MVC-40H

(50kg) 
 中折れハンドル型 
 本体価格:
 ¥239,000(税抜)

動画はこちら!



MVC仕様

型式	機械質量 (kg)	機体寸法 (mm)	転圧盤寸法 (mm)	振動数 Hz(v.p.m)	遠心力 kN(kgf)	最大速度 (m/min)	最大作業勾配 % (度)	エンジン (最高出力)
MVC-F60H	65	(A) 900 (B) 590 (C) 825	(D) 510 (E) 350	93 (5,600)	10.1 (1,030)	25	35(20)	ホンダGX120 2.6kW(3.5PS) 4サイクル
MVC-F60H (中折れハンドル型)	66	(A) 920 (B) 590 (C) 860	(D) 510 (E) 350	93 (5,600)	10.1 (1,030)			
MVC-F30H (中折れハンドル型)	38	(A) 810 (C) 820	(D) 385 (E) 290	98 (5,900)	4.9 (500)			
MVC-40H	49	(A) 865 (B) 610 (C) 820	(D) 420 (E) 298	103 (6,200)	7.2(730)			ホンダGX100 2.1kW(2.9PS) 4サイクル
MVC-40H (中折れハンドル型)	50	(A) 885 (B) 610 (C) 850	(D) 420 (E) 298					
MVC-F40HT	53(62)*	(A) 890 (B) 630 (C) 840	(D) 480 (E) 290	97 (5,800)	9.8 (1,000)			ホンダGX120 2.6kW(3.5PS) 4サイクル
MVC-50H	58	(A) 865 (B) 530 (C) 815	(D) 460 (E) 345					
MVC-50H (中折れハンドル型)	59	(A) 880 (B) 530 (C) 850						
MVC-50HT (水タンク付)	61 (69)*	(A) 925 (B) 545 (C) 815						
MVC-50HT (水タンク付中折れハンドル型)	62 (70)*	(A) 940 (B) 545 (C) 850						
MVC-F70H	73	(A) 900 (B) 590 (C) 825	(D) 510 (E) 420	93 (5,600)	12 (1,220)	25	35(20)	ホンダGX160 3.6kW(4.9PS) 4サイクル

* () 質量は、水タンクを満タンにした運転質量です。